

# **Model 7054 High Voltage Scanner Card**

---

Instruction Manual

Contains Operating and Servicing Information

**KEITHLEY**

## WARRANTY

Keithley Instruments, Inc. warrants this product to be free from defects in material and workmanship for a period of 3 years from date of shipment.

Keithley Instruments, Inc. warrants the following items for 90 days from the date of shipment: probes, cables, rechargeable batteries, diskettes, and documentation.

During the warranty period, we will, at our option, either repair or replace any product that proves to be defective.

To exercise this warranty, write or call your local Keithley representative, or contact Keithley headquarters in Cleveland, Ohio. You will be given prompt assistance and return instructions. Send the product, transportation prepaid, to the indicated service facility. Repairs will be made and the product returned, transportation prepaid. Repaired or replaced products are warranted for the balance of the original warranty period, or at least 90 days.

## LIMITATION OF WARRANTY

This warranty does not apply to defects resulting from product modification without Keithley's express written consent, or misuse of any product or part. This warranty also does not apply to fuses, software, non-rechargeable batteries, damage from battery leakage, or problems arising from normal wear or failure to follow instructions.

THIS WARRANTY IS IN LIEU OF ALL OTHER WARRANTIES, EXPRESSED OR IMPLIED, INCLUDING ANY IMPLIED WARRANTY OF MERCHANTABILITY OR FITNESS FOR A PARTICULAR USE. THE REMEDIES PROVIDED HEREIN ARE BUYER'S SOLE AND EXCLUSIVE REMEDIES.

NEITHER KEITHLEY INSTRUMENTS, INC. NOR ANY OF ITS EMPLOYEES SHALL BE LIABLE FOR ANY DIRECT, INDIRECT, SPECIAL, INCIDENTAL OR CONSEQUENTIAL DAMAGES ARISING OUT OF THE USE OF ITS INSTRUMENTS AND SOFTWARE EVEN IF KEITHLEY INSTRUMENTS, INC., HAS BEEN ADVISED IN ADVANCE OF THE POSSIBILITY OF SUCH DAMAGES. SUCH EXCLUDED DAMAGES SHALL INCLUDE, BUT ARE NOT LIMITED TO: COSTS OF REMOVAL AND INSTALLATION, LOSSES SUSTAINED AS THE RESULT OF INJURY TO ANY PERSON, OR DAMAGE TO PROPERTY.

## KEITHLEY

Test Instrumentation Group, Keithley Instruments, Inc. • 28775 Aurora Road • Cleveland, Ohio 44139 • (216) 248-0400 • Fax: (216) 248-6168

CHINA: Keithley Instruments, Inc. • Holiday Inn Lido • Office Building 404C • Beijing, China, 100004 • 8610-436-2871/2860 • 8610-436-2871  
FRANCE: Keithley Instruments SARL • 3 Allée des Garays • B.P. 60 • 91122 Palaiseau Cédex • 01-60-11-51-55 • Fax: 01-60-11-77-26  
GERMANY: Keithley Instruments GmbH • Landsberger Str. 65 • 82110 Germering • 089-849307-0 • Fax: 089-84930759  
GREAT BRITAIN: Keithley Instruments, Ltd. • The Minster • 58 Portman Road • Reading, Berkshire RG30 1EA • 01734-575666 • Fax: 01734-596469  
ITALY: Keithley Instruments SRL • Viale S. Gimignano 38 • 20146 Milano • 02-48303008 • Fax: 02-48302274  
JAPAN: Keithley Instruments Far East KK • Sumiyoshi 24 Bldg., Room 201 • 2-24-2 Sumiyoshi-cho • Naka-ku, Yokohama 231 • 81-45-201-2246 • Fax: 81-45-201-2247  
NETHERLANDS: Keithley Instruments BV • Avelingen West 49 • 4202 MS Gorinchem • Postbus 559 • 4200 AN Gorinchem • 01830-35333 • Fax: 01830-30821  
SWITZERLAND: Keithley Instruments SA • Kriesbachstrasse 4 • 8600 Dübendorf • 01-821-9444 • Fax: 01-820-3081

# Model 7054 High Voltage Scannr Card Instruction Manual

© 1987, Keithley Instruments, Inc.  
Test Instrumentation Group  
All rights reserved.  
Cleveland, Ohio, U.S.A.  
February 1987, Third Printing  
Document Number: 7054-901-01 Rec. C

## SAFETY PRECAUTIONS

The following safety precautions should be observed before using this product and any associated instrumentation. Although some instruments and accessories would normally be used with non-hazardous voltages, there are situations where hazardous conditions may be present.

This product is intended for use by qualified personnel who recognize shock hazards and are familiar with the safety precautions required to avoid possible injury. Read the operating information carefully before using the product.

Exercise extreme caution when a shock hazard is present. Lethal voltage may be present on cable connector jacks or test fixtures. The American National Standards Institute (ANSI) states that a shock hazard exists when voltage levels greater than 30V RMS, 42.4V peak, or 60VDC are present. **A good safety practice is to expect that hazardous voltage is present in any unknown circuit before measuring.**

Before operating an instrument, make sure the line cord is connected to a properly grounded power receptacle. Inspect the connecting cables, test leads, and jumpers for possible wear, cracks, or breaks before each use.

For maximum safety, do not touch the product, test cables, or any other instruments while power is applied to the circuit under test. ALWAYS remove power from the entire test system and discharge any capacitors before: connecting or disconnecting cables or jumpers, installing or removing switching cards, or making internal changes, such as installing or removing jumpers.

Do not touch any object that could provide a current path to the common side of the circuit under test or power line (earth) ground. Always make measurements with dry hands while standing on a dry, insulated surface capable of withstanding the voltage being measured.


Do not exceed the maximum signal levels of the instruments and accessories, as defined in the specifications and operating information, and as shown on the instrument or test fixture rear panel, or switching card.


Do not connect switching cards directly to unlimited power circuits. They are intended to be used with impedance limited sources. NEVER connect switching cards directly to AC main. When connecting sources to switching cards, install protective devices to limit fault current and voltage to the card.

When fuses are used in a product, replace with same type and rating for continued protection against fire hazard.

Chassis connections must only be used as shield connections for measuring circuits, NOT as safety earth ground connections.

If you are using a test fixture, keep the lid closed while power is applied to the device under test. Safe operation requires the use of a lid interlock.

If a  screw is present on the test fixture, connect it to safety earth ground using #18 AWG or larger wire.

The  symbol on an instrument or accessory indicates that 1000V or more may be present on the terminals. Refer to the product manual for detailed operating information.

Instrumentation and accessories should not be connected to humans.

Maintenance should be performed by qualified service personnel. Before performing any maintenance, disconnect the line cord and all test cables.

# **SPECIFICATIONS**

## **MODEL 7054 HIGH VOLTAGE SCANNER CARD**

**CHANNELS PER CARD:** 10.

**CONTACT CONFIGURATION:** 1-pole Form A, common guard connection.

**CONNECTOR TYPE:** Quick disconnect screw terminal, No. 18 AWG maximum wire size.

**RELAY DRIVE CURRENT:** 50mA (per relay).

**MAXIMUM SIGNAL LEVEL:** 1000V, 0.5A, 10VA peak (resistive load).

**CONTACT LIFE:**  $10^8$  closures (cold switching);  $10^6$  closures (at maximum signal level).

**CONTACT RESISTANCE:**  $< 1\Omega$ .

**ACTUATION TIME:**  $< 20\text{ms}$ , exclusive of mainframe.

**CHANNEL ISOLATION:**  $> 10^{12}\Omega$  and  $< 10\text{pF}$ .

**INPUT ISOLATION:**  $> 10^9\Omega$  and  $< 150\text{pF}$ .

**GUARD TO CHASSIS VOLTAGE:** 200V maximum.

**ENVIRONMENT:**

**Operating:**  $0^\circ$  to  $50^\circ\text{C}$ , up to  $35^\circ\text{C}$  at 70% non-condensing relative humidity.

**Storage:**  $-25^\circ$  to  $+70^\circ\text{C}$ .

**DIMENSIONS, WEIGHT:** 32mm high  $\times$  114mm wide  $\times$  272mm long ( $1\frac{1}{4}'' \times 4\frac{1}{2}'' \times 10\frac{3}{4}''$ ). Net weight 0.28kg (10 oz.).

Specifications subject to change without notice.

# TABLE OF CONTENTS

## SECTION 1 — GENERAL INFORMATION

1.1	Introduction.....	1
1.2	Warranty Information .....	1
1.3	Manual Addenda .....	2
1.4	Safety Symbols and Terms .....	2
1.5	Unpacking and Inspection.....	2
1.6	Specifications .....	3

## SECTION 2 — OPERATION

2.1	Introduction.....	5
2.2	Safety Precautions .....	5
2.3	Wiring.....	5
2.4	Installation and Removal .....	6
2.5	Operating Considerations .....	6
2.6	Applications.....	11
2.7	Switch Terminology .....	13

## SECTION 3 — SERVICING INFORMATION

3.1	Introduction .....	15
3.2	Handling and Cleaning .....	15
3.3	Recommended Test Equipment.....	16
3.4	Contact Resistance Test .....	16
3.5	Isolation Tests .....	18
3.5.1	Channel Isolation .....	18
3.5.2	Input Isolation .....	19

## SECTION 4 — REPLACEABLE PARTS

4.1	Introduction.....	21
4.2	Replaceable Parts .....	21
4.3	Ordering Information .....	22
4.4	Factory Service .....	22
4.5	Component Layout and Schematic Diagram.....	22

# LIST OF TABLES

## SECTION 3 — SERVICING INFORMATION

3-1	Recommended Test Equipment .....	16
-----	----------------------------------	----

## SECTION 4 — REPLACEABLE PARTS

4-1	Model 7054 Replaceable Parts .....	21
-----	------------------------------------	----

# LIST OF ILLUSTRATIONS

## SECTION 2 — OPERATION

2-1	Limiting Capacitive Reaction Current .....	9
2-2	Limiting Inductive Reaction Voltage .....	10
2-3	Measuring 3-Phase Voltages .....	12
2-4	Switch Terminology .....	13

## SECTION 3 — SERVICING INFORMATION

3-1	Contact Resistance .....	17
3-2	Channel Isolation .....	19
3-3	Input Isolation .....	20

## SECTION 4 — REPLACEABLE PARTS

4-1	Model 7054 Component Layout .....	23
4-2	Model 7054 Schematic Diagram .....	25



# SECTION 1

## GENERAL INFORMATION

### 1.1 INTRODUCTION

The Model 7054 is a high voltage scanner card that switches signal levels up to 1000V, 0.5A or 10VA peak (10mA at 1000V) for resistive loads only. Each of the 10 channels on the card consists of a single-pole, Form A (normally open) relay with a common guard connection and a fused input. The output connection and the input connections have quick disconnect screw terminals with a maximum allowable wire size of No. 18 AWG.

Single-pole switching is done in less than 20msec exclusive of the mainframe, and the specified contact life is  $10^8$  closures with cold switching and  $10^6$  closures at maximum signal levels. Contact resistance is less than  $1\Omega$ . The relay drive current is 50mA/relay.

The Model 7054 is field installable in an appropriate Keithley scanner mainframe (e.g. Model 705 or Model 706). With the isolation between each channel being greater than  $10^{12}\Omega$  and less than 10pF, each channel is well insulated from cross channel noise and interference.

### 1.2 WARRANTY INFORMATION


Warranty information is stated on the inside front cover of this manual. If there is a need for service, contact the Keithley representative or authorized repair facility in your area. Check the back cover for addresses. The service form supplied at the end of the manual should be used to provide the service facility with information concerning any difficulty.


## 1.3 MANUAL ADDENDA

Product improvements or changes to this manual will be explained on an addendum included with the manual. It is recommended that this information be incorporated immediately into the appropriate places in the manual.

If an additional instruction manual is required, order the manual package (Keithley Part Number 7054-901-00). The manual package includes an instruction manual and all pertinent addenda.

## 1.4 SAFETY SYMBOLS AND TERMS

The symbol  on the card denotes that the user should refer to the operating instructions.

The symbol  denotes that a high voltage may be present on the terminals.

The **WARNING** used in this manual explains dangers that could result in personal injury or death.

The **CAUTION** used in this manual explains hazards that could damage the instrument.

## 1.5 UNPACKING AND INSPECTION

The Model 7054 was inspected both electrically and mechanically before shipment. Upon receiving the Model 7054, unpack all items from the shipping carton and check for any obvious damage that may have occurred during transit. Report any damage to the shipping agent. Retain and use the original packaging materials in case reshipment is necessary. The following items are shipped with every Model 7054:

Model 7054 High Voltage Scanner Card

Model 7054 Instruction Manual

## **1.6 SPECIFICATIONS**

Detailed specifications of the Model 7054 precede the Table of Contents of this manual.

# SECTION 2 OPERATION

## 2.1 INTRODUCTION

This section provides information needed to use the Model 7054 High Voltage Card with the Model 705 and 706 scanner mainframes. Once the card is installed in the mainframe, refer to the mainframe instruction manual for complete operating instructions.

## 2.2 SAFETY PRECAUTIONS

### WARNING

**User supplied lethal voltages may be present on the PC board or the connections. Turn off all power and discharge stored energy in external circuitry before making or breaking connections.**

1. Do not exceed the Model 7054 maximum voltages of  $\pm 1000V$  peak terminal to terminal and  $\pm 1350V$  peak terminal to chassis.
2. Make sure the scanner mainframe is grounded through an earth grounded receptacle before operation.
3. Inspect all test lead connections for wear and defects such as cracks and exposed wires.
4. Use appropriately rated cables when switching high voltages.

## 2.3 WIRING

Each channel on the Model 7054 card consists of a single-pole, Form A (normally open) switching relay. The Model 7054 will switch any one of the 10 signals (inputs) to one output, or switch one signal to any one of 10 outputs.

### **NOTE**

Because of the high impedance of the board, take special care when handling and using to prevent degradation of performance. Handle the board by the edges to avoid contaminating it with dirt, body oil, etc. For cleaning instructions, see paragraph 3.2.

1. Wiring is accomplished by means of terminal strips as shown on the component layout. See Figure 4-1. Each channel has a HI connection and a LO (GUARD) connection. LO (Guard) is common to all channels.
2. Resistance of the relay contacts path is less than  $1\Omega$ .
3. A common guard surrounds all analog signal paths.
4. Use wires or cables that are rated for greater than 1000V. The maximum allowable wire size is No. 18 AWG. The minimum wire size is No. 26 AWG.
5. Route the wires through the rubber clamp pads located at the rear of the card.

## **2.4 INSTALLATION AND REMOVAL**

Once the card is wired, insert it card edge first into the scanner mainframe by aligning it with the grooves in the appropriate slot. Make sure it is properly seated into the mainframe connector. Push the locking tabs forward to the center of the card to lock it in.

To remove a card, first turn off the mainframe and all other equipment connected to the card. Unfasten the locking tabs on the card by pulling the tabs outward. Grasp the end of the card and carefully pull it out of the mainframe.

## **2.5 OPERATING CONSIDERATIONS**

Since the Model 7054 is a 10-channel card, set the scanner to the 2-pole mode when using the Model 7054 by itself or when intermixing with

other 10-channel cards (such as Models 7056, 7058, 7059, and 7066). In the 2-pole scanner mode, each scanner channel controls one channel on one 10-channel card.

**Signal Levels**—The maximum signal levels for the Model 7054 High Voltage Card are 1000V maximum, 0.5A or 10VA peak (10mA at 1000V) for resistive loads only. The specified contact life is 10<sup>8</sup> closures with cold switching and 10<sup>6</sup> closures at maximum signal levels.

### **WARNING**

**When switching signals greater than 30V RMS or 42.2V peak take care to prevent contact with live circuits which could cause electrical shock resulting in injury or death.**

**Cables**—Shielded cables should be used with the Model 7054 card when switching above 50V. The shield should be connected to the circuit LO (GUARD). This prevents excessive radiation from the cables from interfering with any equipment. The cables must be rated for greater than 1000V.

**Fusible Links**—The Model 7054 scanner card has a fusible link in series with the high input side of each channel relay. A link opens when the current level on that channel becomes excessive because of an external circuit misapplication or a relay failure. The links protect the PC board from damage that is difficult to repair (e.g. lifted or burned traces on the board).

The links are covered with Plexiglas® shields to prevent mechanical damage and still provide a visual check. A repair procedure follows:

1. Unscrew the Plexiglas® shield. Clean out the PC board feedthru holes for the fusible link with a desoldering tool.
2. Insert a jumper of No. 38 AWG magnet wire into the holes and solder in place.

### CAUTION

**When replacing the fusible links, use only No. 38 AWG magnet wire. Use of any other wire may cause severe damage to the PC board.**

3. Check the same channel's relay contacts for a short or insufficient input isolation resistance and replace the relay if necessary.
4. Clean the PC board and Plexiglas® shield according to the instructions given in paragraph 3.2, then remount the shield.

Depending on your application, a current limiting resistor can be used in place of a fusible link. Each resistor will limit the current flow through one channel. The resistors must be of sufficient power rating to safely dissipate any overload.

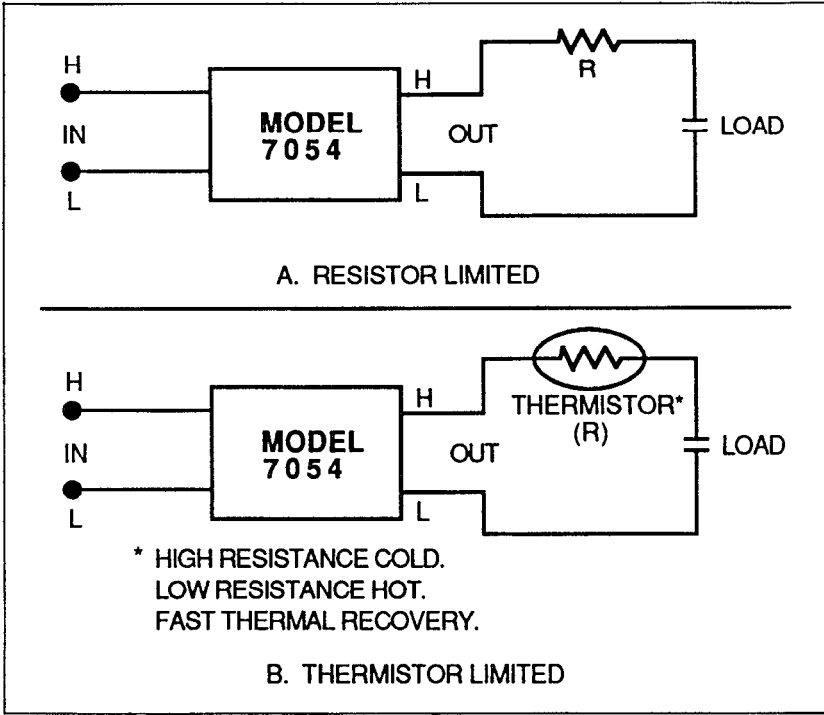
**Reactive Loads**—The Model 7054 is specified for resistive loads. Since reactive loads can cause excessive currents and voltages, current surge limiting (for capacitive loads) and voltage clamping (for inductive loads) are required to prevent damaging the relays and external circuitry.

1. **Capacitive Loads** - The surge current from a capacitive load must be less than 0.5A to protect the relays. Figure 2-1 shows typical circuits to limit current surges. Also, consider the maximum load of 10VA when determining the current limit. For example, when switching 500V, the current must be limited to 20mA ( $I = 10VA/500V$ ) and the limiting resistor calculation of Figure 2-1A would be:

$$R = V/I = 500V/20mA = 25k\Omega$$

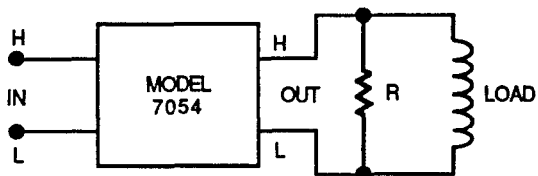
2. **Inductive Loads** - Inductive reaction voltage,  $L(di/dt)$ , must be less than 1000V. Typical clamping circuits are shown in Figure 2-2. Also, consider the maximum load of 10VA when determining the voltage limit. For example, when switching 40mA, the voltage must be limited to 250V ( $V = 10VA/40mA$ ) and the clamping resistor calculation of Figure 2-2A would be:

$$R = V/I = 250V/40mA = 6250\Omega$$

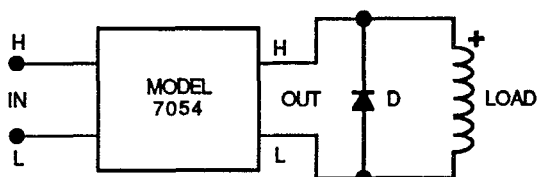


**Figure 2-1. Limiting Capacitive Reaction Current**

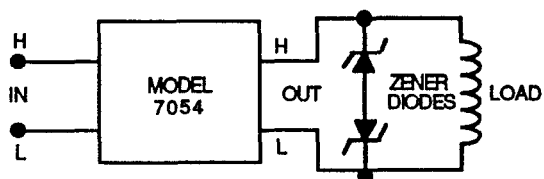




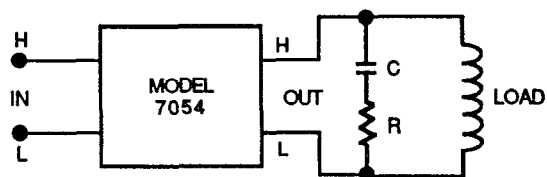
A. RESISTOR CLAMPED (AC OR DC VOLTAGES)



B. DIODE CLAMPED (DC VOLTAGES)



C. ZENER CLAMPED (AC VOLTAGES)



D. RESISTOR-CAPACITOR CLAMPED (AC VOLTAGES)

**Figure 2-2. Limiting Inductance Reaction Voltage**

## 2.6 APPLICATIONS

The Model 7054 can monitor high voltages from ten different circuits or switch a high voltage source to ten separate circuits.

### CAUTION

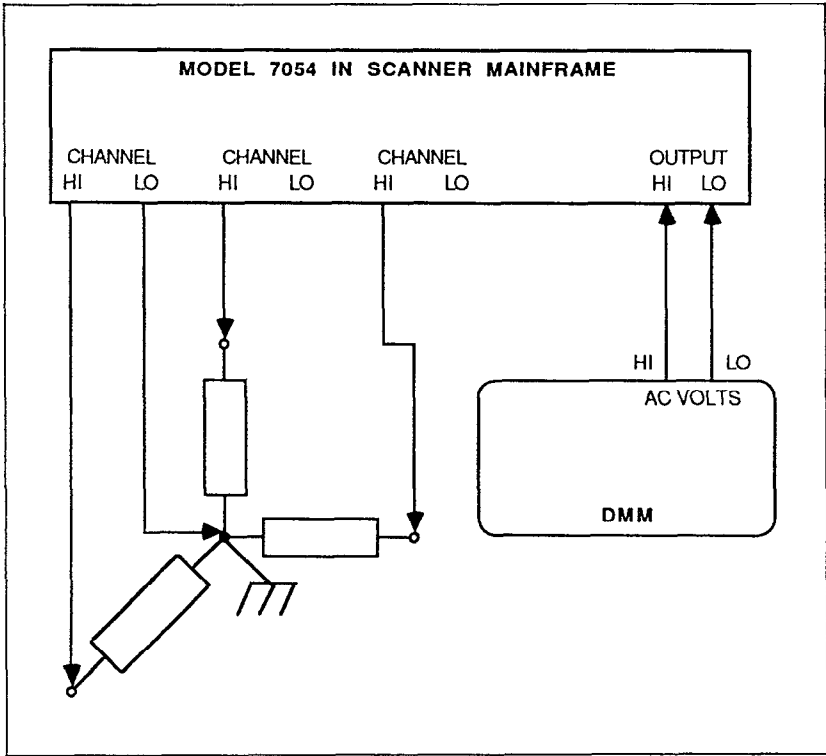
**Because of the high voltage applications of the Model 7054, only one channel relay should be energized at a time. If the break before make operation of the scanner channels is hindered by the application, the card could be damaged.**

As an example of measuring high voltages, consider the sensing application shown in Figure 2-3. Three-phase line or load voltages are switched by the Model 7054 for monitoring. Since LO is common to all channels and the output of the card, only one of the channel LOs is connected.

To prevent card damage, voltage clamping is necessary when monitoring line voltages. Current limiting or voltage clamping are necessary when measuring capacitive or inductive loads. Put the protection circuitry between the source of the transient and the card.

An example of switching a high voltage source is given in Application Note #700, "Switching in Multipoint Testing". A Model 7054 and a divider network are used to incrementally increase the output of a Model 247 High Voltage Supply.

This application is suitable for tests such as insulation resistance of cables, harnesses, and PC boards, high-pot testing, and breakdown testing on semiconductors.

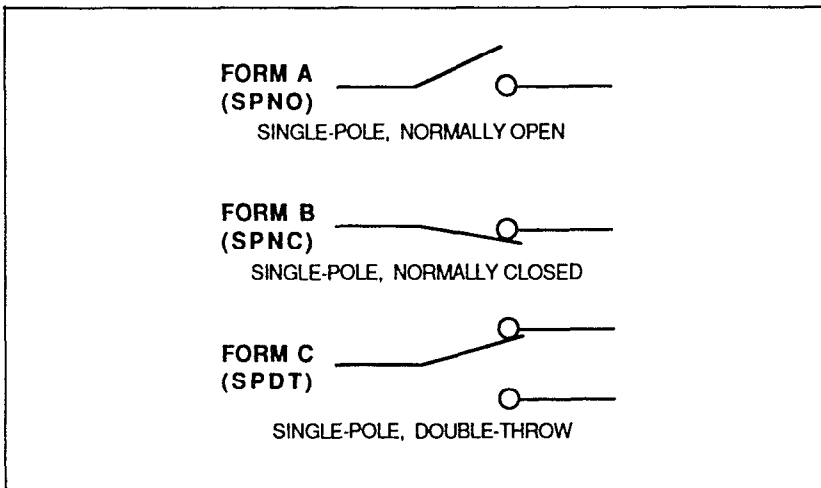


**Figure 2-3. Measuring 3-Phase Voltages**

## 2.7 SWITCH TERMINOLOGY

Terms used to describe switch configurations (see Figure 2-4) are defined as follows:

1. Form A is a single-pole, normally open (SPNO) switch. A 2-pole, normally open switch is called 2 Form A.
2. Form B is similar to Form A except that its contacts are normally closed (SPNC). A 2-pole, normally closed switch is called 2 Form B.
3. Form C is a single-pole, double-throw switch (SPDT). A 2-pole configuration is called 2 Form C.



**Figure 2-4. Switch Terminology**

# SECTION 3

## SERVICING INFORMATION

### 3.1 INTRODUCTION

This section describes tests for verifying the performance of the Model 7054. The tests include:

- Functionality test - Measuring contact resistance to check for open or shorted relays or bad connections.
- Specification tests - Two isolation tests measuring leakage currents to check for a contaminated board and possibly bad relays.

Perform these tests in an environment within the specified operating temperature range (0° to 35°C up to 70% RH) of the scanner card.

#### **WARNING**

**Do not perform the procedures in this section unless you are a qualified service person. Some of the procedures may expose you to potentially lethal voltages (> 30V RMS) that could result in personal injury or death if normal safety precautions are not observed.**

Recommended maintenance includes inspection of the scanner card and the card edge connector to ensure good electrical contact. The Model 7054 does not require calibration.

### 3.2 HANDLING AND CLEANING

Because of the high impedance of the board, take special care when handling and using to prevent degradation of performance. Handle the board by the edges to avoid contaminating it with dirt, body oil, etc.

To clean the board, spray on an uncontaminated solvent, such as Freon® TMS or TE and clean with cotton swabs or a soft brush. After the solvent has been applied and is still liquid, blow-dry the board with dry nitrogen gas.

### 3.3 RECOMMENDED TEST EQUIPMENT

Table 3-1 lists recommended test equipment for performance verification. Other test equipment may be substituted if specifications equal or exceed those stated.

**NOTE**

Since the Model 617 electrometer has an internal 100V source, it can be used in the V/I mode instead of the Model 614 electrometer and Model 230 voltage source.

**Table 3-1. Recommended Test Equipment**

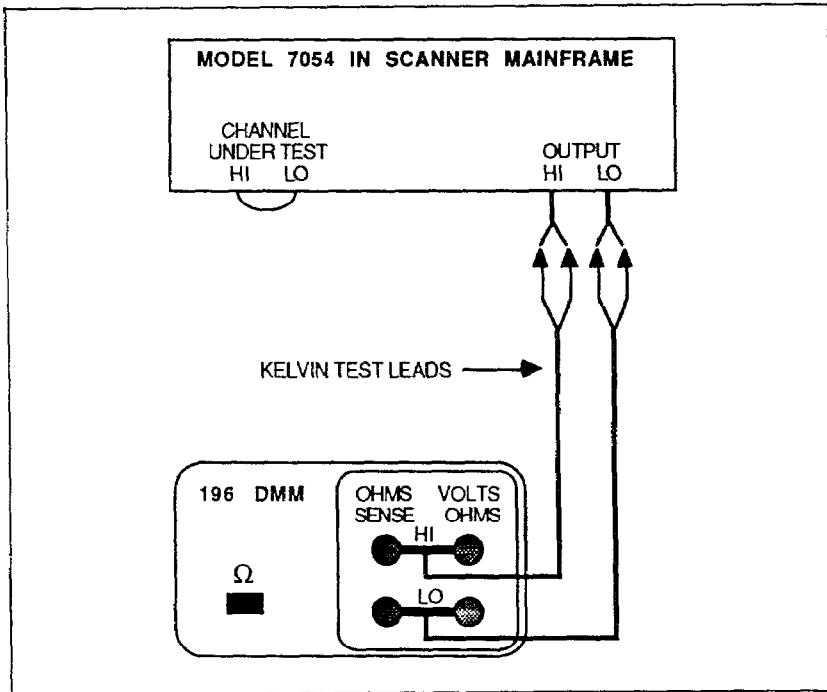
Description	Specification	Mfr.	Model
Scanner Mainframe	—	Keithley	705 or 706
Extender Card	—	Keithley	7061
DMM	<1Ω sensitivity	Keithley	196
Voltage Source	100VDC	Keithley	230
Electrometer	10 <sup>-10</sup> A	Keithley	614 or 617

### 3.4 CONTACT RESISTANCE TEST

This test measures the resistance of each relay contact in an opened and closed state.

1. Set up the equipment as shown in Figure 3-1. Short the HI terminal to the LO terminal of each channel. Attach two copper wires to the output HI and LO terminals.

2. Zero the Model 196 with the Kelvin test leads shorted together.
3. Set the channel mainframe to the channel mode, channel 1, and the step mode. Close channel 1 from the scanner front panel. The reading on the Model 196 should indicate a short circuit (less than  $1\Omega$ ).
4. Open channel 1 from the scanner front panel. The reading on the Model 196 should indicate an open circuit.
5. Repeat steps 3 and 4 for the remaining channels on the card.



**Figure 3-1. Contact Resistance**

## 3.5 ISOLATION TESTS

The two isolation tests measure leakage currents for calculating leakage resistances on the Model 7054. With the Model 7061 Universal Adapter Card, these tests can be performed faster.

### 3.5.1 Channel Isolation

This test measures the leakage current between two channels.

1. Set up the equipment as shown in Figure 3-2.
2. Set the scanner to channel 1 and the step mode. Program channel 1 open and the other channels as closed.
3. Set the electrometer to amps and zero check. Program the Model 230 to output 100V. Take the electrometer out of zero check.
4. The electrometer should read less than  $10^{-10}$ A. (Due to the capacitance of the circuit, the offset current may be high until the circuit capacitance is charged up. Wait until the readings settle out.)
5. Using Ohm's law, calculate the channel isolation (the leakage resistance between two channels). For example:

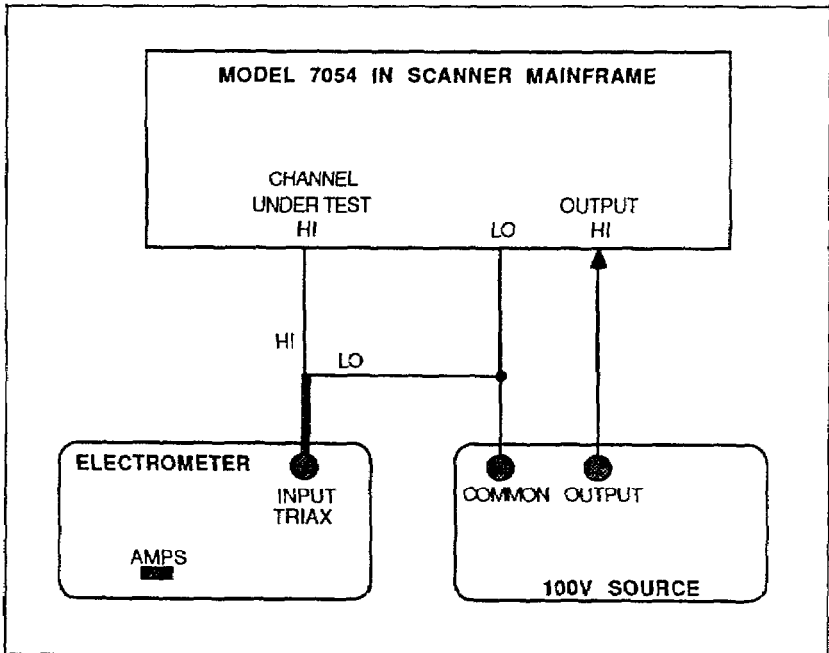
$$R = E/I = 100V/10^{-10}A = 10^{12}\Omega$$

#### NOTE

With the Model 617 electrometer in V/I mode, the resistance is calculated automatically.

6. Put the Model 230 in standby mode and set the electrometer to zero.
7. Repeat steps 2 through 6 for the remaining channels.





**Figure 3-2. Channel Isolation**

### 3.5.2 Input Isolation

This test measures the leakage current between a channel's HI and LO terminals.

1. Set up the equipment as shown in Figure 3-3.
2. Set the scanner to channel 1 and the step mode. Program all channels as open.
3. Set the electrometer to amps and zero check. Program the Model 230 to output 100V. Take the electrometer out of zero check.
4. The electrometer should read less than  $10^{-7}$ A. (Due to the capacitance of the circuit, the offset current may be high until the circuit capacitance is charged up. Wait until the readings settle out.)

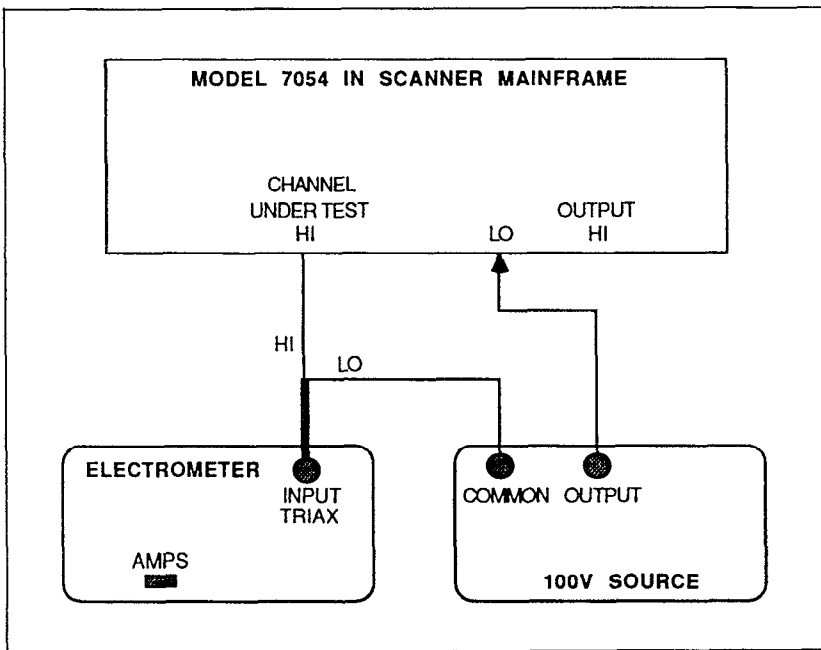
5. Using Ohm's law, calculate the input isolation (leakage resistance) for this channel. For example:

$$R = E/I = 100V/10^{-7}A = 10^9\Omega.$$

**NOTE**

With the Model 617 electrometer in V/I mode, the resistance is calculated automatically.

6. Put the Model 230 in standby mode and set the electrometer to zero.  
7. Repeat steps 2 through 6 for the remaining channels.



**Figure 3-3. Input Isolation**

# SECTION 4 REPLACEABLE PARTS

## 4.1 INTRODUCTION

This section contains replacement parts information, a component layout, and a schematic diagram for the Model 7054.

## 4.2 REPLACEABLE PARTS

Table 4-1 lists parts alphanumerically in the order of their circuit designations.

**Table 4-1. Model 7054 Replaceable Parts**

Circuit Desig.	Description	Keithley Part No.
C101	Capacitor, 10 $\mu$ F, 25V, Aluminum Electrolytic	C-314-10
J1001	Connector	CS-464-1
J1002	Connector	CS-464-2
J1003	Connector	CS-464-2
K101- K110	Relay, Single-Pole Form A	RL-76
SQ101- SQ110	Fusible Link, No. 38 AWG Magnet Wire	—
	Plexiglas <sup>®</sup> Shield	7054-302
	Upper Clamp Assembly	7055-303-05
	Lower Clamp Assembly	7055-308

### **4.3 ORDERING INFORMATION**

To place an order or to obtain information about replacement parts, contact your Keithley representative or the factory. See the back cover for addresses. When ordering, include the following information:

- Model number
- Serial number
- Part description
- Circuit description (if applicable)
- Keithley part number

### **4.4 FACTORY SERVICE**

If fault can be isolated to a particular card, then it is sufficient to return just the card(s). Otherwise, send back both the card(s) and the scanner mainframe. For service, photocopy and complete the service form which follows this section and return it with the equipment.

### **4.5 COMPONENT LAYOUT AND SCHEMATIC DIAGRAM**

Figure 4-1 shows a component layout of the Model 7054. Figure 4-2 shows the schematic diagram of the Model 7054.

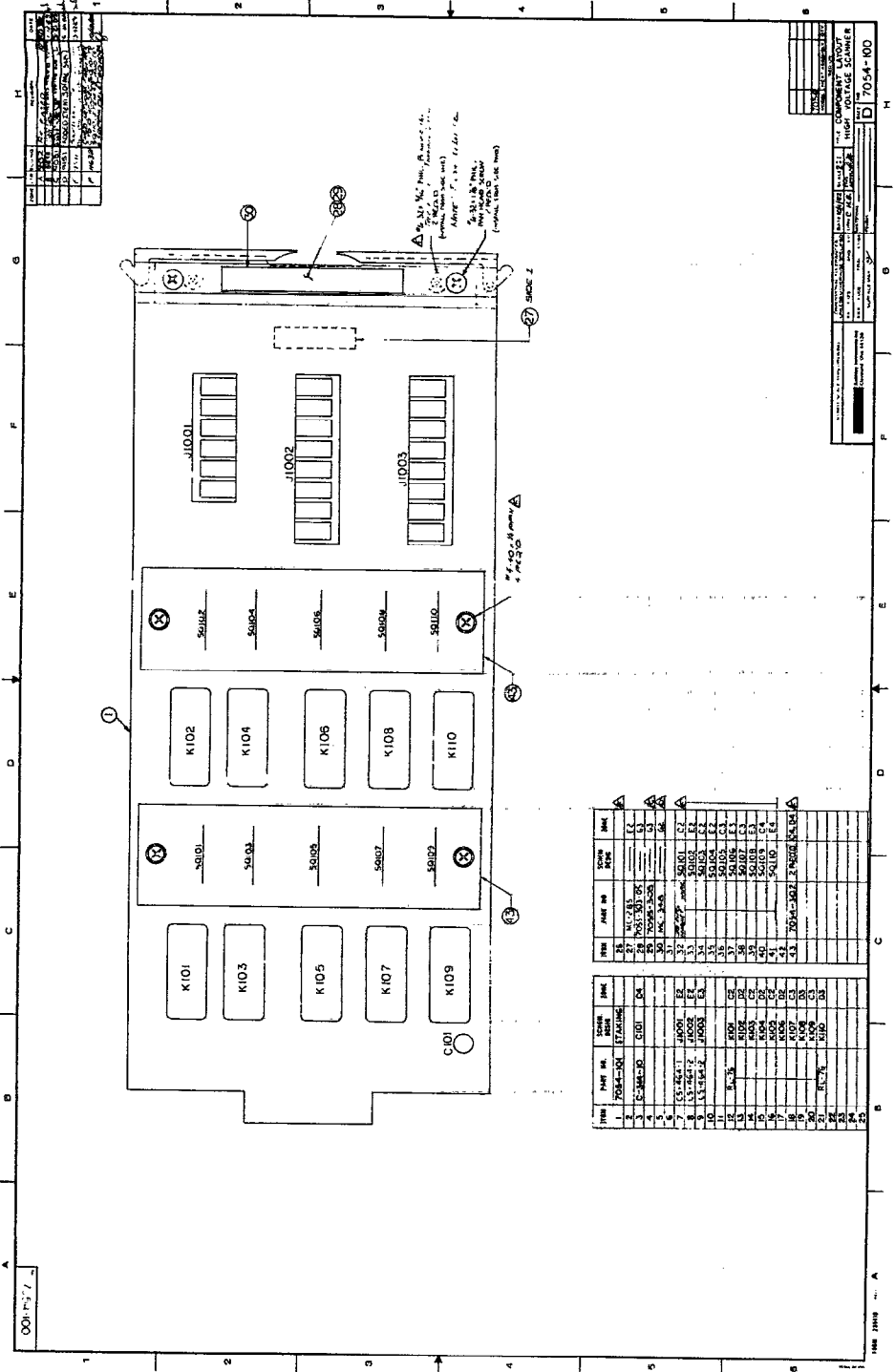
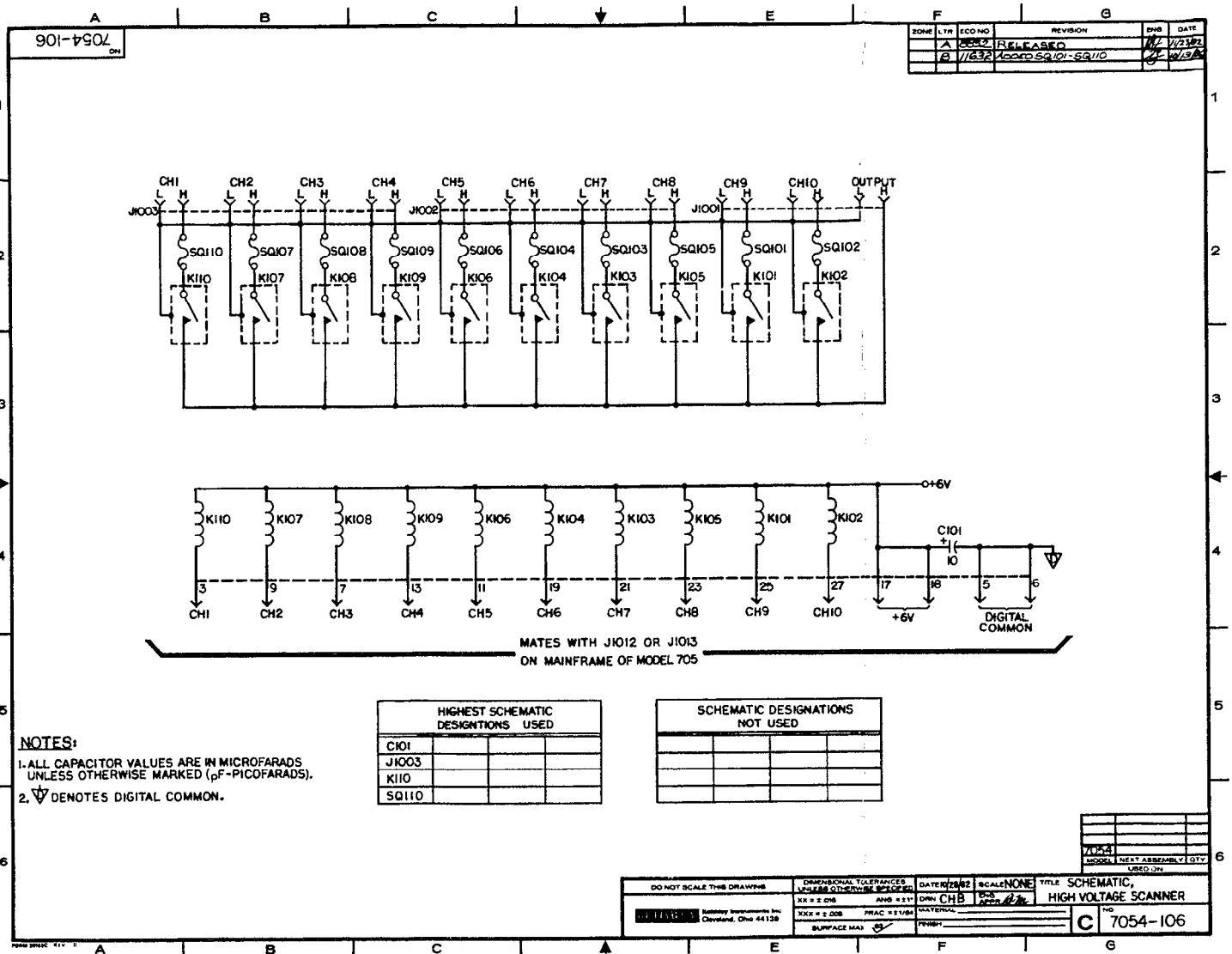


Figure 4-1. Model 7054 Component Layout



**Figure 4-2. Model 7054 Schematic Diagram**



# Service Form

Model No. \_\_\_\_\_ Serial No. \_\_\_\_\_ Date \_\_\_\_\_

Name and Telephone No. \_\_\_\_\_

Company \_\_\_\_\_

List all control settings, describe problem and check boxes that apply to problem. \_\_\_\_\_

- |  |  |  |
|--|--|--|
| <input type="checkbox"/> Intermittent            | <input type="checkbox"/> Analog output follows display   | <input type="checkbox"/> Particular range or function bad; specify |
| <input type="checkbox"/> IEEE failure            | <input type="checkbox"/> Obvious problem on power-up     | <input type="checkbox"/> Batteries and fuses are OK                |
| <input type="checkbox"/> Front panel operational | <input type="checkbox"/> All ranges or functions are bad | <input type="checkbox"/> Checked all cables                        |

Display or output (check one)

- |   |  |
|---|--|
| <input type="checkbox"/> Drifts           | <input type="checkbox"/> Unable to zero                      |
| <input type="checkbox"/> Unstable         | <input type="checkbox"/> Will not read applied input         |
| <input type="checkbox"/> Overload         |  |
| <input type="checkbox"/> Calibration only | <input type="checkbox"/> Certificate of calibration required |
| <input type="checkbox"/> Data required    |  |

(attach any additional sheets as necessary)

Show a block diagram of your measurement system including all instruments connected (whether power is turned on or not). Also, describe signal source.

Where is the measurement being performed? (factory, controlled laboratory, out-of-doors, etc.)

What power line voltage is used? \_\_\_\_\_ Ambient temperature? \_\_\_\_\_ °F

Relative humidity? \_\_\_\_\_ Other? \_\_\_\_\_

Any additional information. (If special modifications have been made by the user, please describe.)

Be sure to include your name and phone number on this service form.

**KEITHLEY**

**Keithley Instruments, Inc.**  
**Test Instrumentation Group**

28775 Aurora Road  
Cleveland, Ohio 44139

Printed in the U.S.A.